



# **OUTBOARD MOTOR**

## **OWNER'S MANUAL**

**T90BM/BE/FE**

**T85BM/BE/FE**

**T75BM/BE/FE**

**T60BM/BE/FE**

**SUZHOU PARSUN POWER MACHINE CO., LTD.**

**Thank you for owning a PARSUN outboard motor.**

**Thank you for your trust in our company and products.**

- “PARSUN” outboard motors are powerful, economic and safe with advanced technology and processing technique.
- Please read this manual carefully before operating your outboard motor. A thorough understanding of the manual will help you to know this product for proper operation, maintenance and care. This will ensure that your outboard motor is operated well under various conditions.
- “PARSUN” seeks continuous improvement in product quality. Therefore, while this manual contains the most current product information available at the time of printing, there may be minor discrepancies between your machine and this manual. If there is any question concerning the manual, please consult your local PARSUN dealer.
- Data, illustrations or explanations in this Owner’s Manual do not constitute base for any legal claim against our company.

**SUZHOU PARSUN POWER MACHINE CO., LTD**





## **Table of contents**

1. Main components and General information .....	1
1.1 Main components .....	1
1.2 General information .....	4
1.2.1 Specifications .....	4
1.2.2 Fueling instructions .....	5
1.2.3 Propeller selection .....	6
2. Operation .....	8
2.1 Installation .....	8
2.1.1 Mounting height .....	9
2.1.2 Clamping the outboard motor .....	9
2.2 Breaking in engine .....	10
2.3 Pre-operation checks .....	11
2.4 Filling fuel .....	12
2.5 Starting engine .....	13
2.6 Warming up engine .....	22
2.7 Shifting .....	23
2.7.1 Forward .....	24
2.7.2 Reverse .....	25
2.8 Tiller .....	26
2.9 Stopping engine .....	27
2.10 Trimming outboard motor .....	30
2.11 Tilting up and down .....	31
2.11.1 Tilting up .....	31
2.11.2 Tilting down .....	33
2.12 Cruising in other conditions .....	35
2.12.1 Cruising in shallow water .....	35
2.12.2 Cruising in salt water .....	36

3. Maintenance	37
3.1 Greasing	37
3.2 Cleaning and adjusting spark plug	38
3.3 Checking fuel system	38
3.3.1 Cleaning the fuel filter	39
3.4 Inspecting idling speed	40
3.5 Checking wiring and connectors	40
3.6 Checking for leakage	40
3.7 Checking propeller	41
3.7.1 Removing the propeller	42
3.7.2 Installing the propeller	42
3.8 Changing gear oil	43
3.9 Cleaning fuel tank	44
3.10 Checking and replacing anode(s)	45
3.11 Checking top cowling	46
3.12 Maintenance table	47
4. Transporting and storing outboard motor	49
4.1 Transporting	49
4.2 Storing	50
5. Action in emergency	53
5.1 Impact damage	53
5.2 Starter will not operate	53
5.3 Treatment of submerged motor	55
6. Troubleshooting	57
7. Circuit diagram	61

# 1. Main components and General information

## 1.1 Main components

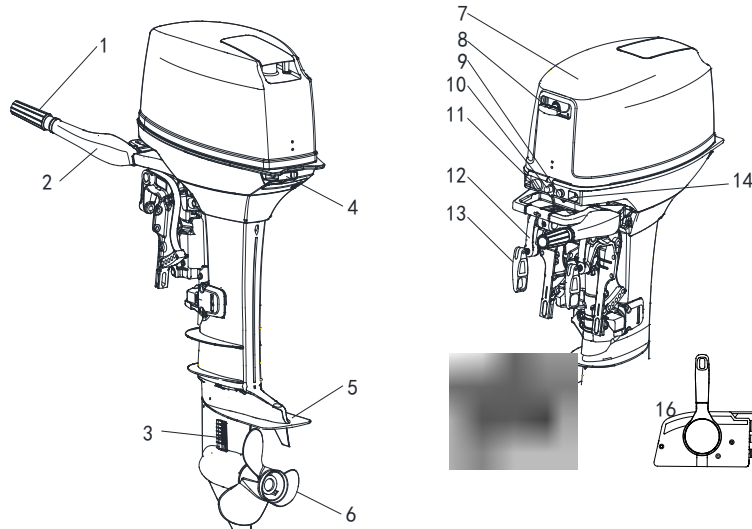

1. Throttle grip

2. Tiller handle

3. Cooling water inlet

4. Top cowling lock handle

5. Anti-cavitation plate

6. Propeller

7. Top cowling

8. Manual starter handle(BM)

9. choke knob

10. Engine stop button/

Engine stop lanyard switch

11. Main switch/choke switch(FE)

12. Clamp bracket

13. Clamp screw

14. Fuel joint

15. Fuel tank

16. Remote control

If your model includes a portable fuel tank, its parts are as follows:

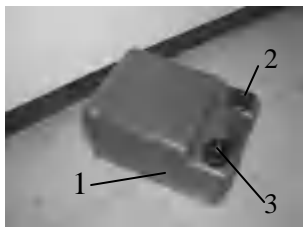

1. Fuel tank cap
2. Fuel joint

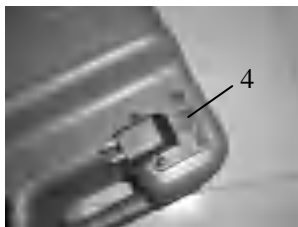

3. Air vent screw
4. Fuel gauge

## **⚠️WARNING**

**The fuel tank supplied with this engine could only be used as supply of fuel for its running and must not be as a fuel storage container.**

## **Remote control**

The remote control lever actuates both the shifter and the throttle. The electrical switches are mounted on the remote control box.

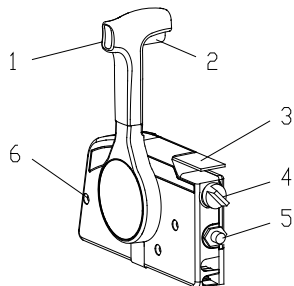

1. Remoter control lever
2. Neutral interlock trigger
3. Neutral throttle lever
4. Main switch/choke switch
5. Engine stop lanyard switch
6. Throttle friction adjuster



## Remote control lever

Moving the lever forward from the neutral position engages forward gear. Pulling the lever back from neutral engages reverse. The engine will continue to run at idle until the lever is moved about 35° (a detent can be felt). Moving the lever farther opens the throttle, and the engine will begin to accelerate.

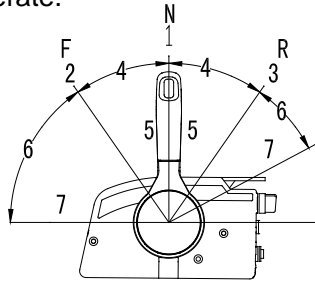

1. Neutral “N”
2. Forward “F”
3. Reverse “R”
4. Shift
5. Fully closed
6. Throttle
7. Fully open

## Neutral interlock trigger

To shift out of neutral, first pull the neutral interlock trigger up.

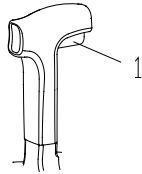

1. Neutral interlock trigger

## Neutral throttle lever

To open the throttle without shifting into either forward or reverse, put the remote control lever in the neutral position and lift the neutral throttle lever.

### NOTE:

**The neutral throttle lever will operate only when the remote control lever is in neutral. The remote control lever will operate only when the neutral throttle lever is in the closed position**

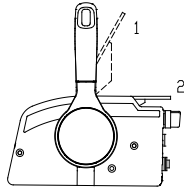

1. Fully open
2. Fully closed

## 1.2 General information

### 1.2.1 Specifications

#### Parameter

Items	Data	Items	Data
Type of engine	2-stroke L	Weight X (BM/BE/FE)	115kg/119kg/119kg
Displacement	1141cm <sup>3</sup>	Transom L	508mm
Bore X stroke	82.0mm×72.0mm	Transom X	635mm
Gear ratio	2.00 (26/13)	Recommended fuel	Unleaded regular gasoline
Overall length (BM/EX)	1337mm/726mm	Recommended engine oil	2-stroke engine oil
Overall width (BM/FW)	398mm/374mm	Recommended gear oil	Hypoid gear oil SAE#90
Overall height L (BM/BE/FE)	1623mm/1548mm/1548mm	Gear oil quantity	610cm <sup>3</sup>
Overall height X (BM/BE/FE)	1497mm/1422mm/1422mm	Spark plug	BR8HS-10
Weight L(BM/BE/FE)	118kg/122kg/122kg	Spark plug gap	0.9~1.0mm

## Performance

Items	Data		Items	Data	
Maximum output	(90HP)	66.2kw/5000 rpm	Idling speed (in neutral)		
	(85HP)	62.5kw/5000 rpm	Tightening torque for engine	Spark plug	25.0Nm
	(75HP)	55.2kw/5000 rpm		Propeller nut	35.0Nm
	(60HP)	44.1kw/5000 rpm			
Full throttle operating range	4500~5500 rpm				

### 1.2.2 Fueling instructions

Fueling instructions:

Recommended gasoline:  
Regular unleaded gasoline, If it is not available,  
then premium gasoline.

If knocking or pinging occurs, use a different brand of gasoline or premium unleaded fuel. If leaded gasoline is usually used, engine valves and related parts should be inspected after every 100 hours of operation.

#### **WARNING:**

- **Do not smoke when refueling, and keep away from sparks, flames, or other sources of ignition.**
- **Stop engine before refueling.**
- **Refuel in a well-ventilated area. Refuel portable fuel tanks off the boat.**
- **Do not overfill the fuel tank.**
- **Take care not to spill gasoline, if gasoline spills, wipe it up immediately.**
- **Tighten the filler cap securely after refueling.**

- If you should swallow some gasoline, inhale a lot of gasoline vapor, or get gasoline in your eye, get immediate medical attentions.
- If any gasoline spills onto your skin, immediately wash with soap and water. Change clothing if gasoline spills on it.
- Touch the fuel nozzle to metal components to prevent electrostatic sparks.

**CAUTION:**

Use only new clean gasoline which has been stored in clean containers and is not contaminated with water or foreign matter.

Engine oil:

Recommended engine oil: 2-stroke outboard motor oil.

Gasoline and oil mixing:

Break-in period		25:1			
	Gasoline	1L	12L	14L	24L
	Engine oil	0.04L	0.48L	0.56L	0.96L
After break-in		50:1			
	Gasoline	1L	12L	14L	24L
	Engine oil	0.02L	0.24L	0.28L	0.48L

**CAUTION:**

Be sure to mix gasoline and oil completely, otherwise the engine may be damaged.

### 1.2.3 Propeller selection

The performance of your outboard motor will be critically affected by your choice of propeller, as an

incorrect choice could adversely affect performance. The outboard motor is fitted with propellers chosen to perform well over a range of applications, but there may be uses where a propeller with a different pitch would be more appropriate. "PARSUN" dealers stock a range of propellers and can advise you and install a propeller on your outboard that is best suited to your application.

For a greater boat load and a low engine speed, a smaller-pitch propeller is more suitable. Conversely, a large-pitch propeller is more suitable for a smaller operating load as it enables the correct engine speed to be maintained.

## 2. Operation

### 2.1 Installation

Mount the outboard motor on the center line (keel line) of the boat. For boats without a keel or which are asymmetrical, consult your dealer.

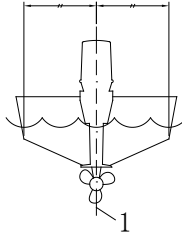

1. Center line (keel line)

#### NOTE:

During water testing check the buoyancy of the boat, at rest, with its maximum load. Check that the static water level on the exhaust housing is low enough to prevent water entry into the power head, when water rises due to waves when the outboard is not running.

#### WARNING:

- **Overpowering a boat could cause severe instability. Do not install an outboard motor with more horsepower than the maximum rating on the capacity plate of the boat. If the boat does not have a capacity plate, consult the boat manufacturer.**
- **Improper mounting of the outboard motor could result in hazardous conditions.**  
For permanently mounted models, your dealer or other person experienced in proper rigging should mount the motor. If you are mounting the motor yourself, you should be trained by an experienced person. For portable models, your dealer or other person experienced in proper outboard motor mounting should show you how to mount your motor.
- **The information presented in this section is intended as reference only. Proper mounting depends in part on experience and the specific boat and motor combination.**

## 2.1.1 Mounting height

The mounting height of the outboard motor greatly affects your boat running efficiency. If the mounting height is too high, cavitation tends to occur, thus reducing the propulsion. If the mounting height is too low, the water resistance will increase and thereby reduce engine efficiency. Mount the outboard motor so that the anti-cavitation plate is between the bottom of the boat and a level 25mm below it.

### NOTE:

The optimum mounting height of the outboard motor is affected by the boat and motor combination and the desired use. Test runs at a different height can help determine the optimum mounting height. For further information, consult your “PARSUN” dealer or boat manufacturer.

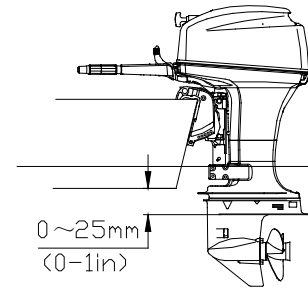

## 2.1.2 Clamping the outboard motor

1. Tighten the transom clamp screw evenly and securely. Occasionally check the clamp screws for tightness during operation of the outboard motor because they could become loose due to engine vibration.

### CAUTION:

Outboards that use clamp bracket screws alone are **INSUFFICIENT** to properly and safely secure the outboard to the Transom. Proper installation of the outboard includes bolting the engine to the boat through the transom.

### ⚠ WARNING:

- Loose clamp screws could allow the outboard motor to fall off or move on the transom. This could cause loss of control.



- **Make sure the clamp screws are tightened securely. Occasionally check the screws for tightness during operation.**

2. If the engine restraint cable attachment is equipped on your engine, an engine restraint cable or chain should be used. Attach to a secure mounting point on the boat to avoid the engine being completely lost if it accidentally falls off the transom.



3. Secure the clamp bracket to the transom using the appropriate bolts. For details, consult your PARSUN dealer.

**⚠ WARNING:**

**Avoid using bolts, nuts or washers inappropriate. After tightening, test running the engine and check their tightness.**

## 2.2 Breaking in engine

Your new engine requires a period of break-in to allow mating surfaces of moving parts to wear in evenly. Gasoline and oil mixing:

Break-in period	25:1				
	Gasoline	1L	12L	14L	24L
	Engine oil	0.04L	0.48L	0.56L	0.96L

**CAUTION:**

**Failure to follow the break-in procedure could result in reduced engine life or even severe engine damage.**

1. First 10 minutes:  
Run the engine at idle.



2. Next 50 minutes:  
Run the engine at 3000 r/min or at approximately half throttle.
3. Next 2 hours of operation:  
Run the engine at 4000 r/min or at approximately three-quarter throttle.
4. Next 7 hours of operation:  
Avoid continuous operation at full throttle for more than five minutes at a time.
5. Operate the engine normally.

## **2.3 Pre-operation checks**

### **Fuel**

- Check to be sure you have plenty of fuel for your trip.
- Make sure there are no fuel leaks or gasoline fumes.
- Check fuel line connections to be sure they are tight.
- Be sure the fuel tank is positioned on a secure, flat surface, and that the fuel line is not twisted or flattened, or likely to contact sharp objects.

### **Controls**

- Check throttle, shift and steering for proper operation before starting the engine.
- The controls should work smoothly, without binding or unusual free play.
- Look for loose or damaged connections.
- Check operation of the starter and stop switches when the outboard motor is in the water.

### **Engine**

- Check the engine and engine mounting.

- Look for loose or damaged fasteners.
- Check the propeller for damage.

**⚠ WARNING:**

If any item in the pre-operation check is not working properly, have it inspected and repaired before operating the outboard motor. Otherwise an accident could occur.

**CAUTION:**

Do not start the engine out of water. Overheating and serious engine damage can occur.

## 2.4 Filling fuel

**⚠ WARNING:**

Gasoline and its vapors are highly flammable and explosive. Keep away from sparks, cigarettes, flames, or other sources of ignition.

1. Remove the fuel tank cap.
2. Carefully fill the fuel tank.



3. Securely close the cap after filling the tank. Wipe up any spilled fuel.

## 2.5 Starting engine

### For BM

1. Loosen the air vent screw on the fuel tank cap, 2 or 3 turns.

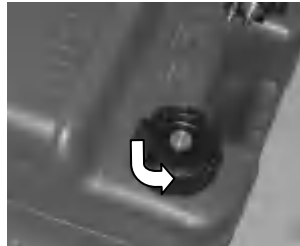

2. Connect fuel joints securely and squeeze the primer pump with the outlet end up until you feel it become firm (if equipped the fuel joint).



3. Place the gear shift lever in neutral.



**⚠ WARNING:**

- The engine must be started in neutral otherwise damage to the starter can occur.
- Do not attach the lanyard to clothing that could tear loose. Do not route the lanyard where it could become entangled, preventing it from functioning.
- Avoid accidentally pulling the lanyard during normal operation. Loss of engine power means the loss of steering control. Also, without engine power, the boat could slow rapidly. This could cause people and objects in the boat to be thrown forward.

**NOTE:**

The start-in-gear protection device prevents the engine from starting except when in neutral. Attach the engine stop switch lanyard to secure place on your clothing, or your arm or leg. Then install the lock plate on the other end of the lanyard into the engine stop switch.



4. Place the throttle grip in the “START” (start) position.



5. Pull out the choke knob fully.



**NOTE:**

- It is not necessary to use the choke when starting a warm engine.
- If the choke is left in the “START” (start) position while the engine is running, the engine will run poorly or stall.

6. Pull the manual starter handle slowly until you feel resistance. Then give a strong pull straight to crank and start the engine. Repeat if necessary.

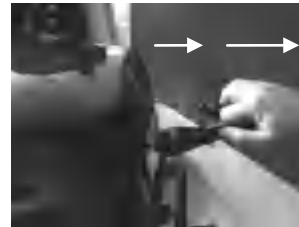

7. After the engine starts, slowly return the manual starter handle to its original position before releasing it.

8. Slowly return the throttle grip to the fully closed position.

**CAUTION:**

- When the engine is cold, it needs to be warmed up.
- If the engine does not start on the first try, repeat the procedure.
- If the engine fails to start after 4 or 5 tries, open the throttle a small amount (between 1/8 and 1/4), and try again.

**For BW**

1. Connect fuel joints securely after loosening the air vent screw on the fuel tank cap(2 or 3 turns).



2. Connect fuel joints securely and squeeze the primer pump with the outlet end up until you feel it become firm(if equipped the fuel joint).



3. Place the remote control lever in neutral.



**Note:**

The start-in-gear protection device prevents the engine from starting except when in neutral. Attach the engine stop switch lanyard to secure place on your clothing, or your arm or leg. Then install the lock plate on the other end of the lanyard into the engine stop switch.

**⚠ WARNING:**

- **The engine must be starting in neutral otherwise damage starter and hazard can occur.**
- **Do not attach the lanyard to clothing that could tear loose. Do not route the lanyard where it could become entangled and preventing it functioning.**
- **Avoid accidentally pulling the lanyard during normal operation. Loss of engine power means the loss of steering control. Also, without engine power, the boat could slow rapidly. This could cause people and objects in the boat to be thrown forward.**



- Place the throttle grip in the “START”(start)position. Turn the main switch to “ON”(on).



- Turn the main switch to “START”(start), and hold it for a maximum of 5 seconds.



- After the engine starts, slowly return the manual starter handle to its original position before releasing it. Immediately after the engine starts, release the main switch and allow it to return to “ON”(on).
- Slowly return the throttle grip to the fully closed position.

**NOTE:**

- **Never turn the main switch to “START”(start)while the engine is running.**
- **Do not keep the starter motor turning for more than 5 seconds. If the starter motor is turned continuously for more than 5 seconds, the battery will be quickly discharged, thus making it impossible to start the engine. The starter can also be damaged. If the engine**



will not start after 5 seconds of cranking, return the main switch to “ON”(on), wait 10 seconds, then crank the engine again.

**NOTE:**

- When the engine is cold, it needs to be warmed up.
- If engine does not start on the first try, repeat the procedure. If the engine fails to start after 4 or 5 tries, open the throttle a small amount (between 1/8 and 1/4), and try again.

**For T36J/40JFW**

1. Loosen the air vent screw on the fuel tank cap, 2 or 3 turns.



2. Connect fuel joints securely and squeeze the primer pump with the outlet end up until you feel it become firm (if equipped the fuel joint).



3. Place the gear shift lever in neutral.

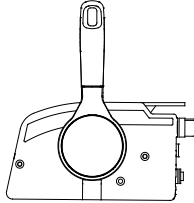

**⚠ WARNING:**

- The engine must be started in neutral otherwise damage to the starter can occur.
- Do not attach the lanyard to clothing that could tear loose. Do not route the lanyard where it could become entangled, preventing it from functioning.
- Avoid accidentally pulling the lanyard during normal operation. Loss of engine power means the loss of steering control. Also, without engine power, the boat could slow rapidly. This could cause people and objects in the boat to be thrown forward.

**NOTE:**

The start-in-gear protection device prevents the engine from starting except when in neutral. Attach the engine stop switch lanyard to secure place on your clothing, or your arm or leg. Then install the lock plate on the other end of the lanyard into the engine stop switch.



4. Turn the main switch to “ON”(on).

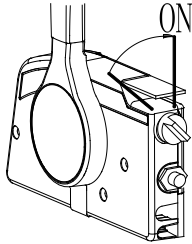

5. Open the throttle slightly without shifting using the neutral throttle lever or free accelerator. You may need to change the throttle opening slightly depending on engine temperature. After The engine starts, return the throttle to the original position.

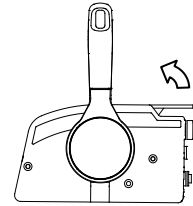

6. Turn the main switch to “START”(start), and hold it for a maximum of 5 seconds.

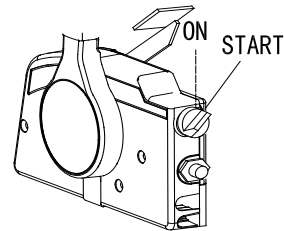

7. After the engine starts, slowly return the manual starter handle to its original position before releasing it. Immediately after the engine starts, release the main switch and allow it to return to "ON"(on).
8. Slowly return the throttle grip to the fully closed position.

**NOTE:**

- **Never turn the main switch to "START" (start) while the engine is running.**
- **Do not keep the starter motor turning for more than 5 seconds. If the starter motor is turned continuously for more than 5 seconds, the battery will be quickly discharged, thus making it impossible to start the engine. The starter can also be damaged. If the engine will not start after 5 seconds of cranking, return the main switch to "ON"(on), wait 10 seconds, then crank the engine again.**
- **On remote controls equipped with a neutral throttle lever, a good starting point is to lift the lever just until you feel resistance, then lift slightly more.**
- **The neutral throttle lever or free accelerator can only be used when the remote control lever is in neutral**
- **It is not necessary to use the choke when starting a warm engine.**
- **If the choke is left the home position while the engine is running, the engine will run poorly or stall.**
- **When the engine is cold, it needs to be warmed up.**

## **2.6 Warming up engine**

1. After starting the engine, allow it to idle for 3 minutes to warm up. Failure to do so will shorten engine life. Gradually return the choke knob to its home position as the engine warms up.

2. Check for steady flow of water from the cooling water pilot hole.

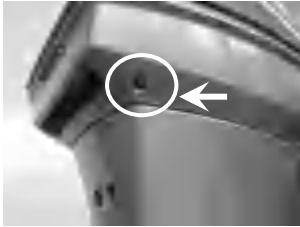

**CAUTION:**

- If water is not flowing out of the hole at all times while the engine is running, stop the engine and check whether the cooling water inlet on the lower case or the cooling water pilot hole is blocked.
- If the problem cannot be located and corrected, consult your dealer.

## 2.7 Shifting

**⚠ WARNING:**

Before shifting, make sure there are no swimmers or obstacles in the water near you.

**CAUTION:**

To shift from forward to reverse or vice versa, first close the throttle so that the engine idles (or runs at low speeds).

## 2.7.1 Forward

### For BM/BW

1. Place the throttle grip in the fully closed position.

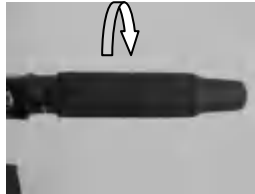

2. Move gear shift lever quickly and firmly from neutral to forward.



### For FW

Pull up the neutral interlock rigger and move the remote control lever quickly and firmly from neutral to forward.

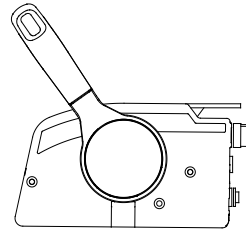

## 2.7.2 Reverse

### **WARNING:**

- When operating in reverse, go slowly. Do not open the throttle more than half.
- Otherwise the boat could become unstable, which could result in loss of control and an accident.

#### **For BM/BW**

1. Place the throttle trip in the fully closed position.

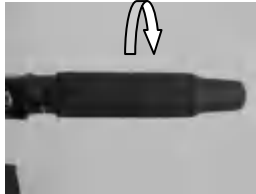

2. Move the gear shift lever quickly and firmly from neutral to reverse.



### **NOTE:**

**Make sure the tilt lock lever is in the lock/down position.**

## For FW

Pull up the neutral interlock rigger and move the remote control lever quickly and firmly from neutral to reverse.

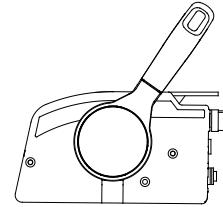

## 2.8 Tiller

### 1. Change direction

To change direction, move the tiller handle to the left or right as necessary.

### 2. Change speed

Turn the grip counterclockwise to increase speed and clockwise to decrease speed.



### 3. Throttle indicator

The throttle indicator is on the throttle grip. The fuel consumption curve on the throttle indicator shows the relative amount of fuel consumed for each throttle position. Choose the setting that offers the best performance and fuel economy for the desired operation.



1. Throttle indicator



#### 4. Throttle friction adjuster

The throttle friction adjuster is on the tiller handle, which provides adjustable resistance to movement of the throttle grip, and can be set according to operator preference. To increase resistance, turn the adjuster clockwise. To decrease resistance, turn the adjuster counterclockwise. When constant speed is desired, tighten the adjuster to maintain the desired throttle setting.



#### **WARNING:**

**Do not over-tighten the friction adjuster. If there is too much resistance, it could be difficult to move throttle lever or grip, which could result in an accident.**

## 2.9 Stopping engine

### **NOTE:**

**Before stopping the engine, first let it cool off for a few minutes at idle or low speed. Stopping the engine immediately after operating at high speed is not recommended.**

### **PROCEDURE:**

#### **For BM/BW**

1. Push and hold the engine stop button until the engine comes to a complete stop.

### **NOTE:**

**If the outboard motor is equipped with an engine stop switch lanyard, the engine can also be stopped by pulling the lanyard and removing the lock plate from the engine stop switch.**



2. Tighten the air vent screw on the fuel tank cap.



3. Disconnect the fuel line if you are using an external fuel tank.



**For FW**

1. Turn the main switch to “**OFF**” (off).

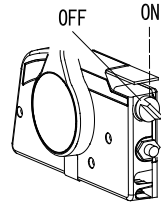

2. Tighten the air vent screw on the fuel tank cap.

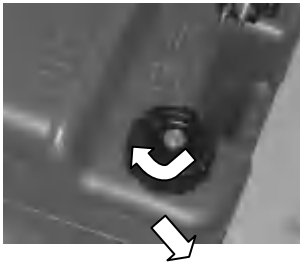

3. Disconnect the fuel line.



## 2.10 Trimming outboard motor

There are 4 or 5 holes provided in the clamp bracket to adjust the outboard motor trim angle.

1. Stop the engine.
2. Remove the trim rod from the clamp bracket while slightly tilting the outboard motor up.



3. Reposition the rod in the desired hole. Make test runs with the trim set to different angles to find the position that works best for your boat and operating conditions.

### **WARNING:**

- **Stop the engine before adjusting the trim angle.**
- **Use care to avoid being pinched when removing or installing the rod.**
- **Use caution when trying a trim position for the first time. Increase speed gradually and watch for any signs of instability or control problems.**
- **Improper trim angle can cause loss of control.**

## 2.11 Tilting up and down

If the engine will be stopped for some time or if the boat is moored in shallows, the outboard motor should be tilted up to protect the propeller and casing from damaged by collision with obstructions, and also to reduce corrosion.

### **WARNING:**

- **Be sure all people are clear of the outboard motor when tilting up and down, also be careful not to pinch any body parts between the drive unit and engine bracket.**
- **Tighten the air vent screw and place the fuel cock in the closed position if the outboard motor will be tilted for more than a few minutes. Otherwise fuel may leak.**

### **NOTE:**

- **Do not tilt up the engine by pushing the tiller handle because this could break the handle.**
- **The outboard motor cannot be tilted when in reverse.**

### 2.11.1 Tilting up

**For BM/BW**

1. Place the gear shift lever in neutral (if equipped) and face the outboard motor forward.



3. Tighten the air vent screw. Disconnect the fuel joint from the outboard motor.



4. Place the tilt lock lever (if equipped) in the up position.



5. Hold the rear of the top cowling , tilt the engine up ,and turn the tilt support lever toward you and then place the tilt lock lever in the down position..



### For FW

1. Place the gear shift lever in neutral (if equipped) and face the outboard motor forward.

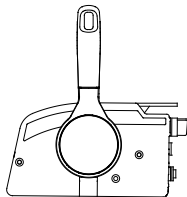

2. Pressing the switch "UP" trims the outboard motor up.

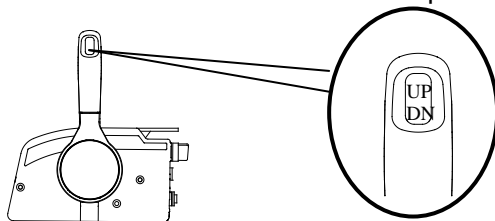

### 2.11.2 Tilting down

#### For BM/BW

1. Slightly tilt the outboard motor up.

2. Place the tilt lock lever (if equipped) in the up position.



3. Hold the rear of the top cowling , tilt the engine up slightly and return the tilt support lever.
4. Slowly tilt the outboard motor down.
5. place the tilt lock lever in the down position..



**WARNING:**

**If there is too much resistance it could be difficult to steer, which could result in an accident.**



## For FW

3. Place the gear shift lever in neutral (if equipped) and face the outboard motor forward.

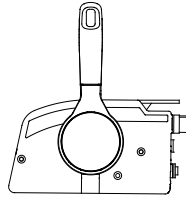

4. Pressing the switch "DN" trims the outboard motor down.

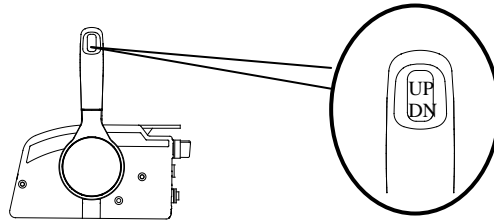

## 2.12 Cruising in other conditions

### 2.12.1 Cruising in shallow water

The outboard motor can be tilted up partially to allow operation in shallow water.

#### **WARNING:**

- The tilt lock mechanism does not work while the shallow water cruising system is being used. Run the boat at the lowest possible speed to avoid the outboard motor being lifted out of the water, resulting in loss of control.

- Return the outboard motor to its normal position as soon as the boat is back in deeper water.

**CAUTION:**

The cooling water inlet on the lower unit should be not above the surface of the water when setting up for and cruising in shallow water. Otherwise severe damage from overheating can result. For tilting procedure, see section 2.11.

### **2.12.2 Cruising in salt water**

After operating in salt water, wash out the cooling water passages with fresh water to prevent them from becoming clogged with salt deposits.

### 3. Maintenance

While using the outboard motor, the periodic maintenance is necessary for you to ensure its performance.

#### **⚠ WARNING:**

Be sure to turn off the engine when you perform maintenance unless otherwise specified. If you or the owner is not familiar with machine servicing, this work should be done by your PARSUN dealer or other qualified mechanic.

#### **CAUTION:**

If replacement parts are necessary, use only genuine PARSUN parts or parts of the same type and of equivalent strength and materials.

#### 3.1 Greasing

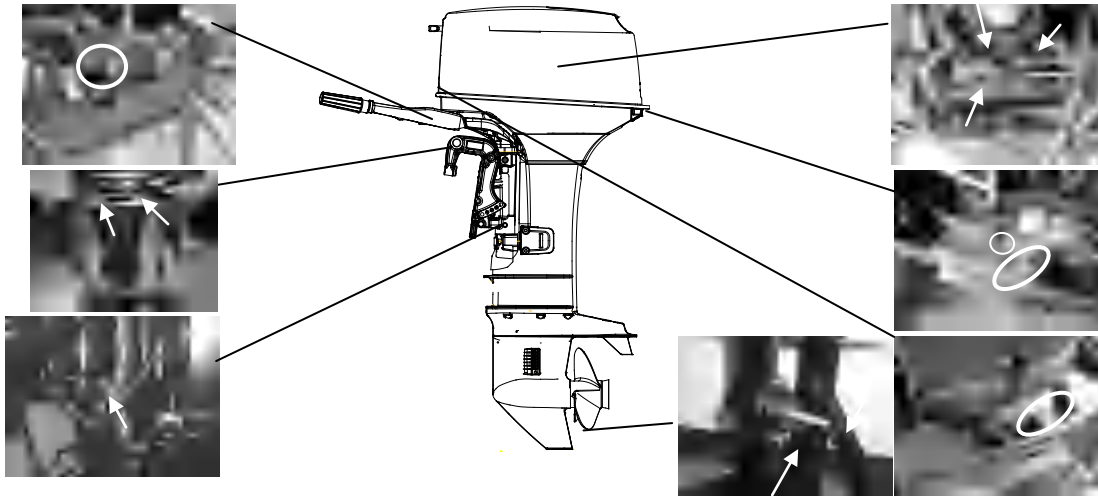

### 3.2 Cleaning and adjusting spark plug

You should periodically remove and inspect the spark plug because heat and deposits will cause the spark plug to slowly break down and erode.

If necessary, you should replace the spark plug with another of the correct type. Before fitting the spark plug, measure the electrode gap with a wire thickness gauge; adjust the gap to specification if necessary.

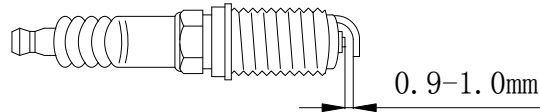

When fitting the plug, always clean the gasket surface and use a new gasket.

Wipe off any dirt from the threads and screw in the spark plug to the correct torque.

### 3.3 Checking the fuel system

1. Check the fuel lines for leaks, crack, or malfunction. If a problem is found, your PARSUN dealer or other qualified mechanic should repair it immediately.



#### **WARNING:**

- Check for fuel leakage regularly.
- If any fuel leakage is found, the fuel system must be repaired by a qualified mechanic.

2. Check the fuel filter periodically. If foreign matter is found in the filter, clean it.

### 3.3.1 Cleaning the fuel filter

1. Removing the nut holding the fuels filter assembly if equipped.



2. Unscrew the filter cup, catching any spilled fuel in a rag.
3. Remove the filter element, and wash it in solvent. Allow it to dry. Inspect the filter element and O-ring of the filter cup to make sure they are in good conditions. Change them if necessary. If any water is found in the fuel, check and clean the portable fuel tank.
4. Reinstall the filter element in the cup. Make sure the O-ring is in position in the cup. Firmly screw the cup onto the filter housing.
5. Attach the filter assembly to the bracket so that the fuel hoses are attached to the filter assembly. Run the engine and check the filter and lines for leaks.

### 3.4 Inspecting idling speed

A diagnostic tachometer should be used for this procedure. Results may vary depending on whether testing is conducted with the flushing attachment in a test tank, or with the outboard motor in the water.

1. Start the engine and allow it to warm up fully in neutral until it is running smoothly.
2. Verify whether the idle speed is set to specification.

Idle speed: 800±50Rpm

#### **CAUTION:**

**Correct idling speed inspection is only possible if the engine is fully warmed up. If not warmed up fully, the idle speed will measure higher than normal. If you have difficulty verifying the idle speed, or the idle speed requires adjustment, consult a PARSUN dealer or other qualified mechanic.**

### 3.5 Checking wiring and connectors

Check that each grounding wire is properly secured and each connector is engaged securely.

### 3.6 Checking for leakage

Check that no exhaust or water leaks from the joints between the exhaust cover, cylinder head, and body cylinder.

Check for oil leaks on the around the engine.

#### **CAUTION:**

**If any leaks are found, consult your PARSUN dealer.**

### 3.7 Checking propeller

#### **⚠️ WARNING:**

- Before inspecting, removing or installing the propeller, always take actions to ensure the engine will not accidentally starts, such as removing the spark plug caps from the spark plugs, placing the shift control in neutral, and removing the lanyard from the engine stop switch, etc.. Serious accident could occur if the engine starts when you are nearby.
- Do not use your hand to hold the propeller when loosening or tightening the propeller nut. Put a wood block between the anti-cavitation plate and the propeller to prevent the propeller from turning.



1. Check each of the propeller blades for wear, erosion from cavitation or ventilation, or other damage.
2. Check the propeller shaft for damage.

3. Check the pin for wear or damage.
4. Check for fish line tangled around the propeller shaft.
5. Check for the propeller shaft oil seal for damage.

### 3.7.1 Removing the propeller

1. Straighten the cotter pin and pull it out using a pair of pliers.
2. Remove the propeller nut, washer, and spacer (if equipped).
3. Remove the propeller and thrust washer.

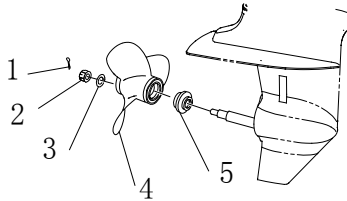

1. Cotter pin
2. Propeller nut
3. Washer
4. Propeller
5. Thrust washer

### 3.7.2 Installing the propeller

#### **CAUTION:**

- Be sure to install the thrust washer before installing the propeller, otherwise the lower case and propeller boss could be damaged.



● **Be sure to use a new cotter pin and bend the ends over securely. Otherwise the propeller could come off during operation and be lost.**

1. Apply a marine grease or corrosion resistant grease to the propeller shaft.
2. Install the spacer (if equipped), thrust washer, and propeller on the propeller shaft.
3. Install the spacer (if equipped) and the washer.
4. Tighten the propeller nut. Align the propeller nut with the propeller shaft hole. Insert a new cotter pin in the hole and bend the cotter pin ends.

### 3.8 Changing gear oil

**⚠ WARNING:**

● **Be sure the outboard motor is securely fastened to the transom or a stable stand.**  
● **Never get under the lower unit while the outboard motor is tilted, even when the tilt support lever or knob is locked. Serious injury could occur if the motor falls.**

1. Tilt the outboard motor so that the gear oil drain screw is at the lowest point possible.
2. Place a suitable container under the gear case.
3. Remove gear oil drain screw.



- 1 . Gear oil drain screw
- 2 . Oil level plug

### **CAUTION:**

Change the gear oil after the first 10 hours of operation, and every 100 hours or at 6-month intervals thereafter. Otherwise the gear will wear quickly.

4. Remove the oil level plug to allow the oil to drain completely.

### **CAUTION:**

Inspect the used oil after it has been drained. If the oil is milky, water is getting into the gear case which can cause gear damage. Consult PARSUN dealer.

5. Use a flexible or pressurized filling device, and inject the gear oil into the gear oil drain screw hole.
6. When the oil begins to flow out of the oil level plug hole, insert and tighten the oil level plug (If necessary, change the seal spacer).
7. Insert and tighten the gear oil drain screw (If necessary, change the seal spacer).

## **3.9 Cleaning fuel tank**

### **WARNING:**

- Keep away from sparks, cigarettes, flames, or other sources of ignition when cleaning the fuel tank.
  - Cleaning the fuel tank in a well-ventilated open air.
1. Empty the fuel tank into an approved container.

- 2 . Pour a small amount of suitable solvent into the tank. Install the cap and shake the tank. Drain the solvent completely.
- 3 . Pull the fuel joint assembly out of the tank.
- 4 . Clean the filter in a suitable cleaning solvent and allow it to dry.
- 5 . Replace the gasket with a new one. Reinstall the fuel joint assembly and tighten the screws firmly.

### **3.10 Checking and replacing anode(s)**

Inspect the external anodes periodically. Remove scales from the surfaces of the anodes. Consult a PARSUN dealer for replacement of external anodes.

#### **CAUTION:**

**Do not paint anodes, as this would render them ineffective and can cause more rapid engine corrosion.**



### 3.11 Checking top cowling

Check the fitting of the top cowling by pushing it with both hands. If it is loose have it repaired by your PARSUN dealer.



### 3.12 Maintenance Table

When utilized under normal condition, maintained and repaired in the proper manner, the motor can work normally within the normal life period.

Frequency of maintenance operations may be adjusted according to the operating conditions, but the following table gives general guidelines.

The “●” symbol indicates the check-ups which you may carry out by yourself.

The “○” symbol indicates work to be carried out by your parsun dealer.

Item	Operations	Initial		Every	
		10 hours (1 month)	50 hours (3 months)	100 hours (6 months)	200 hours (1 year)
Anode(s) (external)	Check/replacement		●/○	●/○	
Anode(s) (internal)	Check/replacement				○
Cooling water passages	Cleaning		●	●	
Cowling clamp	Check				●
Fuel filter (disposable)	Check/cleaning	●	●	●	
Fuel system	Check	●	●	●	
Fuel tank (portable tank)	Check/cleaning				●
Gear oil	Change	●		●	
Greasing points	Greasing			●	

## Continuation /...1

Item	Operations	Initial		Every	
		10 hours (1 month)	50 hours (3 months)	100 hours (6 months)	200 hours (1 year)
Idling speed (carburetor models)	Check/adjustment	●/○		●/○	
Propeller and cotter pin	Check/replacement		●	●	
Shift link/shift cable	Check/adjustment				○
Thermostat	Check				○
Throttle link/throttle cable/ throttle pick-up timing	Check/adjustment				○
Water pump	Check				○
Spark plug (s)	Cleaning/adjustment/ Replacement	●			●

**NOTE:**

**When operating in salt water, turbid or muddy water, the engine should be flushed with clean water after every use.**

## 4. Transporting and storing

### 4.1 Transporting

The outboard motor should be trailed and stored in the normal running position. If there is insufficient road clearance in this position, then trailer the outboard motor in the tilt position using a motor support device.

#### **CAUTION:**

**Do not use the tilt support lever or knob when trailing the boat.**

**The outboard motor could shake loose from the tilt support and fall.**

#### **⚠️ WARNING:**

- **Never get under the lower unit while it is tilted, even if a motor support bar is used.**
- **When transporting or storing the outboard motor while removed from a boat, keep the outboard motor in the attitude shown.**

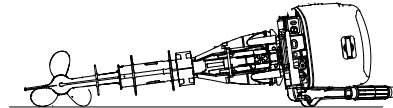
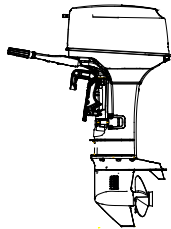

#### **CAUTION:**

**Place a towel or something similar under the outboard motor to protect it from damage.**

## 4.2 Storing

When storing your PARSUN outboard motor for prolonged periods of time (2 months or longer), several important procedures must be performed to prevent excessive damage.

It is advisable to have your outboard motor serviced by an authorized PARSUN dealer prior to storage. However, you, the owner, with a minimum of tools, can perform the following procedures.

### **CAUTION:**

- **Do not place the outboard motor on its side before the cooling water has drained from it completely.**
- **Store the outboard motor in a dry, well-ventilated place, not in direct sunlight.**

1. Wash the outboard motor body using fresh water.
2. Disconnect the fuel line and tighten the air vent screw.
3. Remove the engine top cowling and silencer cover.
4. Install the outboard motor on the test tank.

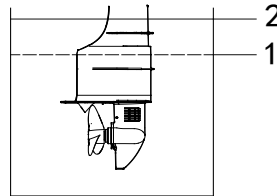

1. Lowest water level
2. Water surface



5. Fill the tank with fresh water to above the level of the anti-cavitation plate.

**CAUTION:**

**If the fresh water level is below the level of the anti-cavitation plate, or if the water supply is insufficient, engine seizure may occur.**

6. Start the engine. Flush the cooling system. Perform the flushing and fogging at the same time, as fogging/lubricating of the engine is mandatory to prevent engine rust.

** WARNING:**

- **Do not touch or remove electrical parts when starting or during the operation.**
- **Keep hands, hair, and clothes away from the flywheel and other rotating parts while the engine is running.**

7. Run the engine at a fast idle for a few minutes in neutral position.

8. Just prior to turning off the engine, quickly spray “Fogging Oil” alternately into each carburetor or the fogging hole of the silencer cover, if equipped.

9. If “Fogging Oil” is not available, run the engine at a fast idle until the fuel system empties and the engine stops.

10. If “Fogging Oil” is not available, remove the spark plug(s). Pour a teaspoonful of clean engine oil into each cylinder. Crank several times manually. Replace the spark plug(s).

11. Drain the fuel from the fuel tank completely.

**CAUTION:**

**Portable fuel tank equipped models: Store the portable fuel tank in a dry, well-ventilated place, not in direct sunlight.**

## 5. Actions in emergency

### 5.1 Impact damage

If the outboard motor hits an object in the water, follow the procedure below.

1. Stop the engine immediately.
2. Inspect the control system and all components for damage.
3. Whether damage is found or not, return to the nearest harbor slowly and carefully.
4. Have a PARSUN dealer inspect the outboard motor before operating it again.

### 5.2 Starter will not operate

If the starter mechanism does not operate, the engine can be started with an emergency starter rope.

 **WARNING:**

- **Use this procedure only in an emergency and only to return to port for repairs.**
- **When the emergency starter rope is used to start the engine, the start-in-gear protection device does not operate. Make sure the remote control lever is in neutral.**
- **Be sure no one is standing behind you when pulling the starter rope. It could whip behind you and injure someone.**
- **Do not install the starter mechanism or top cowling after engine is running. Keep loose clothing and other objects away when starting the engine. Do not touch the flywheel or other moving parts when the engine is running.**
- **Do not touch the ignition coil, spark plug wire, spark plug cap, or other electrical components when starting or operating the motor.**

**The procedure is as follows:**

1. Remove the top cowling.
2. Remove the start-in-gear protection cable.



1. Start-in-gear protection cable

3. Remove the starter cover after removing the three bolts.

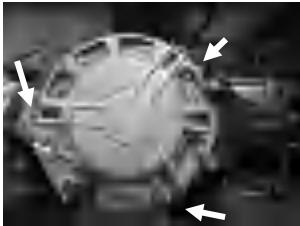

4. Prepare the engine for starting. For further information, see section 2.5.
5. Insert the knotted end of the emergency starter rope into the notch in the flywheel rotor and wind the rope several turns around the flywheel clockwise.
6. Pull the rope slowly until resistance is felt.

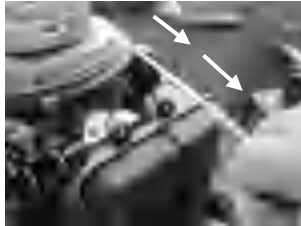

7. Give a strong pull straight out to crank and start the engine. Repeat it necessary.

### **5.3 Treatment of submerged motor**

If the outboard is submerged, immediately take it to a PARSUN dealer. Otherwise some corrosion may begin almost immediately.

1. Thoroughly wash away contaminants with fresh water.

2. Remove the spark plug(s), then face the spark plug hole downward to allow any mud, or contaminants to drain.



3. Fill the sump with fresh engine oil.
4. Feed engine fogging oil or engine oil through the carburetor(s) and spark plug holes while starting the engine.
5. Take the outboard motor to a PARSUN dealer as soon as possible.

**CAUTION:**

**Do not attempt to run the outboard motor until it has been completely inspected.**

## 6. Troubleshooting

Trouble type	Possible reason	Recovery action
Starter will not operate	Starter components are faulty	Have serviced by your dealer
	Shift lever is not in neutral	Shift to neutral
Engine will not start (starter operates)	Fuel tank is empty	Fill tank with clean, fresh fuel
	Fuel is contaminated or stale	Fill tank with clean, fresh fuel
	Fuel filter clogged	Clean or replace with recommended type
	Fuel pump has malfunctioned	Have serviced by your dealer
	Spark plug(s) fouled or of incorrect type	Inspect spark plug(s). Clean or replace with recommended type
	Spark plug cap(s) fitted incorrectly	Check and re-fit cap(s)
	Ignition wiring damaged or poorly connected	Check wires for wear or breaks. Tighten all loose connections. Replace worn or broken wires
	Ignition parts are faulty	Have serviced by your dealer
	Engine stop switch lanyard is not attached	Attach lanyard
Engine inner parts are damaged	Have serviced by your dealer	
Engine idles irregularly or stalls	Spark plug(s) fouled or of incorrect type	Inspect spark plug(s). Clean or replace with recommended type

## Continuation /...1

Trouble type	Possible reason	Recovery action
Engine idles irregularly or stalls	Fuel system is obstructed	Check for pinched or kinked fuel line or other obstructions in fuel system
	Fuel is contaminated or stale	Fill tank with clean, fresh fuel
	Fuel filter clogged	Clean or replace with recommended type
	Spark plug gap is incorrect	Inspect and adjust as specified
	Ignition wiring damaged or poorly connected	Check wires for wear or breaks. Tighten all loose connections. Replace worn or broken wires
	Specified engine oil is not being used	Check and replace oil as specified
	Thermostat is faulty or clogged	Have serviced by your dealer
	Carburetor adjustments are incorrect	Have serviced by your dealer
	Carburetor is clogged	Have serviced by your dealer
	Fuel pump is damaged	Have serviced by your dealer
	Air vent screw on fuel tank is closed	Open air vent screw
	Fuel joint connection is incorrect	Connect correctly
	Throttle valve adjustment is incorrect	Have serviced by your dealer
	Choke knob is pulled out	Return to home position
Motor angle is too high	Return to normal operating position	



## Continuation /...2

<b>Trouble type</b>	<b>Possible reason</b>	<b>Recovery action</b>
Engine power loss	Propeller is damaged	Repair or replace propeller
	Trim angle is incorrect	Adjust trim angle to achieve most efficient operation
	Motor is mounted at incorrect transom height	Adjust motor to proper transom height
	Boat bottom is fouled with marine growth	Clean boat bottom
	Weeds or other foreign matter are tangled on gear housing	Remove foreign matter and clean lower unit
	Spark plug(s) are fouled or incorrect type	Inspect spark plug(s). Clean or replace with recommended type
	Fuel system is obstructed	Check for pinched or kinked fuel line or other obstructions in fuel system
	Fuel filter is clogged	Clean or replace with recommended type
	Fuel is contaminated or stale	Fill tank with clean, fresh fuel
	Spark plug gap is incorrect	Inspect and adjust as specified
	Ignition wiring is damaged or poorly connected	Check wires for wear or breaks. Tighten all loose connections. Replace worn or broken wires
	Ignition parts have failed	Have serviced by your dealer
	Specified engine oil is not being used	Check and replace oil as specified
	Thermostat is faulty or clogged	Have serviced by your dealer
	Air vent screw on fuel tank is closed	Open air vent screw
Fuel pump has malfunctioned	Have serviced by your dealer	

Continuation /...3

<b>Trouble type</b>	<b>Possible reason</b>	<b>Recovery action</b>
Engine power loss	Fuel joint connection is incorrect	Connect correctly
	Specified spark plug(s) are not being used	Check and replace spark plug(s) as specified
Engine vibrates excessively	Propeller is damaged	Repair or replace propeller
	Propeller shaft is damaged	Have serviced by your dealer
	Weeds or other foreign matter are tangled on propeller	Remove and clean propeller
	Motor mounting bolt is loose	Tighten bolt
	Steering pivot is loose	Tighten it
	Steering pivot is damaged	Have serviced by your dealer

## 7. Circuit diagram

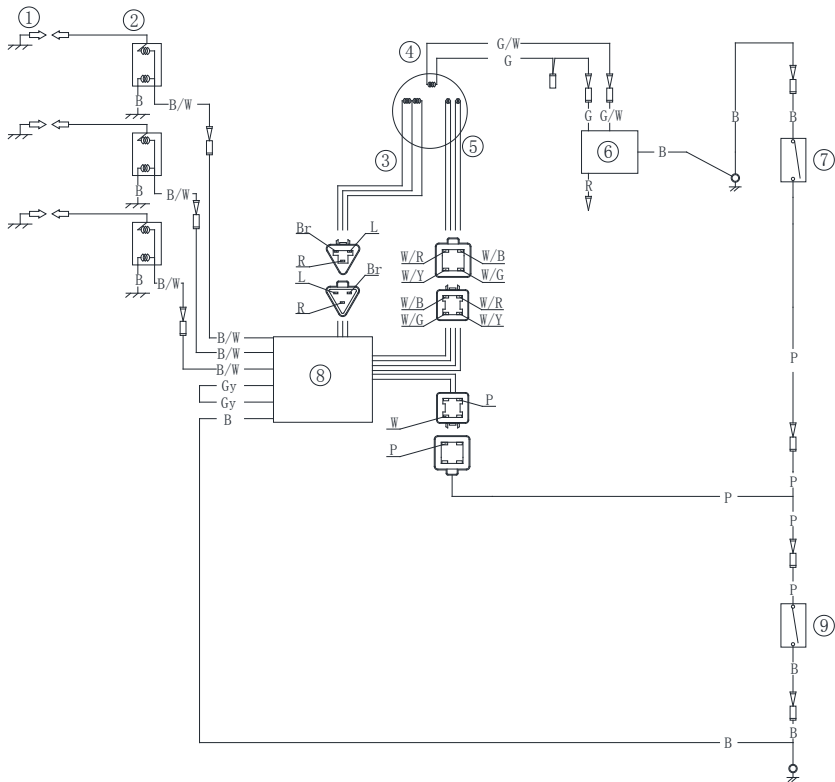

- ① Spark plug
- ② Ignition coil
- ③ Charge coil
- ④ Lighting coil
- ⑤ Pulser coil
- ⑥ Rectifier regulator
- ⑦ Thermo switch
- ⑧ CDI unit
- ⑨ Engine stop switch

R : Red  
 P : Pink  
 B : Black  
 G : Green  
 W : White  
 Gy : Gray  
 W/Y : White/Yellow  
 B/W : Black/White  
 W/B : White/Black  
 W/G : White/Green  
 W/R : White/Red  
 G/W : Green/White

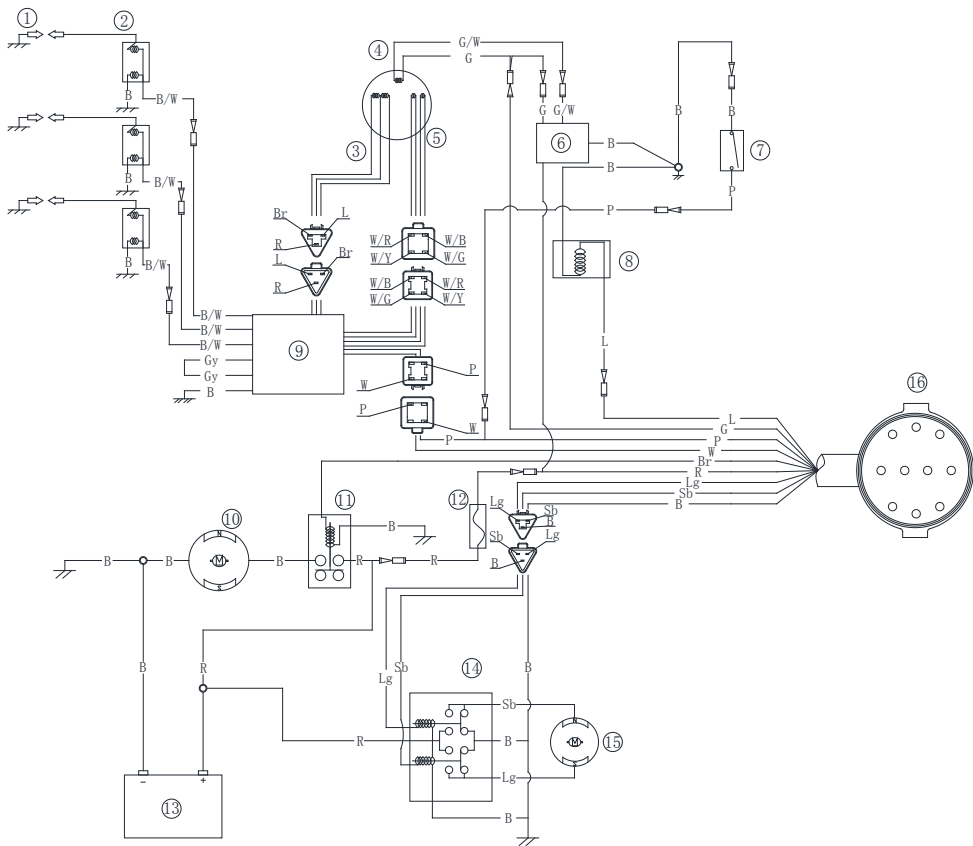

- ① Spark plug
- ② Ignition coil
- ③ Charge coil
- ④ Lighting coil
- ⑤ Pulser coil
- ⑥ Rectifier regulator
- ⑦ Thermo switch
- ⑧ Fuel enrichment valve
- ⑨ CDI unit
- ⑩ Starter motor
- ⑪ Starter relay
- ⑫ Fuse
- ⑬ Battery
- ⑭ P.T.T. motor
- ⑮ P.T.T. relay
- ⑯ 10P coupler

R : Red  
 P : Pink  
 B : Black  
 G : Green  
 Br: Brown  
 W : White  
 L : Blue  
 Gy: Gray  
 Lg: Light green  
 Sb: Sky blue  
 W/Y: White/Yellow  
 B/W: Black/White  
 W/B: White/Black  
 W/G: White/Green  
 W/R: White/Red  
 G/W: Green/White

	W	B	R	Y	Br
OFF	○	○			
ON			○	○	
START			○	○	○

	Sb	R	Lc
UP	○	○	
FREE			
DOWN		○	

